



# Affordable LED replacements for compact fluorescent 4-pin & 2-pin lamps

## PL-C/T

Philips PLED 4-pin & 2-pin lamps are an affordable LED solution to replace compact fluorescent lamps. The product provides a natural lighting effect for use in many lighting applications, and provides instant energy savings, making them an environmentally-friendly solution. Available as replacements for 13W, 26W and 32W compact fluorescent lamps.

### Benefits

- Reduced lighting costs
- Excellent lighting uniformity and lumen maintenance
- Unmatched compatibility with existing ballasts

### Features

- Excellent energy efficiency
- Horizontal lamps rotate to ensure the best possible lighting effect
- Easy installation. Plug-and-play replacement of existing CFL-ni lamps
- Conventional form factor fits into existing luminaires

### Application

- Retail & hospitality
- Residential
- Healthcare

# PL-C/T

## Versions



G24q/GX24q

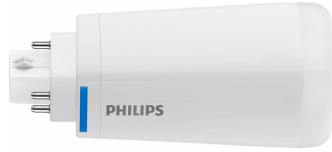

G24q/GX24q



LEDtube GX23-2



LEDtube GX23-2



LEDtube G24Q



LEDtube G24Q

## Dimensional drawing

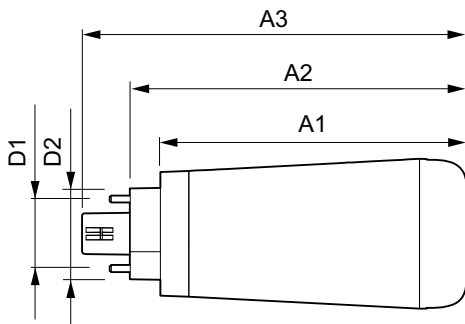

Product	D1	D2	A1	A2	A3
10.5PL-C/T/COR/26V-827/ IF12/P/4P/DIM10/1	24.3 mm	29 mm	99.9 mm	109.9 mm	125.5 mm
10.5PL-C/T/COR/26V-840/ IF13/P/4P/DIM10/1	24.3 mm	29 mm	99.9 mm	109.9 mm	125.5 mm
10.5PL-C/T/COR/26V-835/ IF13/P/4P/DIM10/1	24.3 mm	29 mm	99.9 mm	109.9 mm	125.5 mm
12PLC/T LED/32V/827/IF/4P/DIM 1PK 10/1	24.3 mm	29 mm	99.9 mm	109.9 mm	125.5 mm
12PL-C/T/COR/32V-835/ IF14/P/4P/DIM 10/1	24.3 mm	29 mm	99.9 mm	109.9 mm	125.5 mm
12PL-C/T/COR/32V-830/ IF14/P/4P/DIM 10/1	24.3 mm	29 mm	99.9 mm	109.9 mm	125.5 mm
12PL-C/T/COR/32V-840/ IF15/P/4P/DIM 10/1	24.3 mm	29 mm	99.9 mm	109.9 mm	125.5 mm

Dimensional drawing

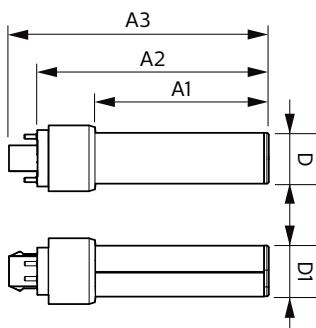
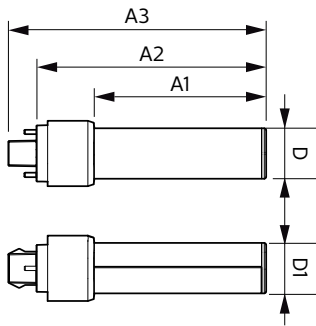
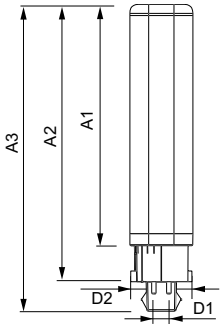

Product	D1	D2	A1	A2	A3
8.5PL-C/T/COR/	24.3	28.4	128.3	147.5	163.1 mm
26H-840/IF9/P/4P/DIM 10/1	mm	mm	mm	mm	
8.5PL-C/T/COR/	24.3	28.4	128.3	147.5	163.1 mm
26H-835/IF9/P/4P/DIM 10/1	mm	mm	mm	mm	
8.5PL-C/T/COR/	24.3	28.4	128.3	147.5	163.1 mm
26H-827/IF8/P/4P/DIM 10/1	mm	mm	mm	mm	
8.5PL-C/T/COR/	24.3	28.4	128.3	147.5	163.1 mm
26H-830/IF9/P/4P/DIM 10/1	mm	mm	mm	mm	
12PL-C/T/COR/32H-835/	24.3	28.4	128.8	148 mm	163.6
IF14/P/4P/DIM 10/1	mm	mm	mm		mm
12PLC/T	24.3	28.4	128.8	148 mm	163.6
LED/32H/827/IF/4P/DIM 1PK	mm	mm	mm		mm
10/1					
12PL-C/T/COR/32H-840/	24.3	28.4	128.8	148 mm	163.6
IF14/P/4P/DIM 10/1	mm	mm	mm		mm
12PL-C/T/COR/32H-830/	24.3	28.4	128.8	148 mm	163.6
IF13/P/4P/DIM 10/1	mm	mm	mm		mm

Product	D	D1	A1	A2	A3
5PL-C/LED/13H/835/IF5/P/2P	27 mm	27 mm	91.5 mm	122.4 mm	137.4 mm
20/1					
5PL-C/LED/13H/840/IF5/P/2P	27 mm	27 mm	91.5 mm	122.4 mm	137.4 mm
20/1					

Product	D	D1	A1	A2	A3
5.5PL-C/LED/13H/835/IF5/P/4P	27 mm	27 mm	91.5 mm	122.4 mm	137.4 mm
20/1					
5.5PL-C/LED/13H/830/IF5/P/4P	27 mm	27 mm	91.5 mm	122.4 mm	137.4 mm
20/1					
5.5PL-C/LED/13H/840/IF5/P/4P	27 mm	27 mm	91.5 mm	122.4 mm	137.4 mm
20/1					

## Dimensional drawing

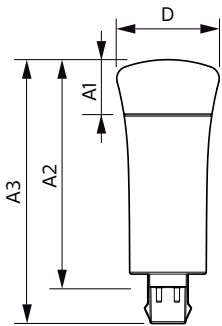
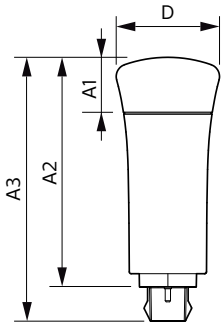

Product	D	A1	A2	A3
5PL-C/LED/13V/835/IF5/P/2P 20/1	45.7 mm	24.6 mm	101.6 mm	117.6 mm
5PL-C/LED/13V/840/IF5/P/2P 20/1	45.7 mm	24.6 mm	101.6 mm	117.6 mm

Product	D	A1	A2	A3
5.5PL-C/LED/13V/835/IF5/P/4P 20/1	45.7 mm	24.6 mm	101.6 mm	117.6 mm
5.5PL-C/LED/13V/827/IF5/P/4P 20/1	45.7 mm	24.6 mm	101.6 mm	117.6 mm
5.5PL-C/LED/13V/840/IF5/P/4P 20/1	45.7 mm	24.6 mm	101.6 mm	117.6 mm

### Approval and Application

Energy Consumption kWh/1000 h	- kWh
Energy Efficiency Label (EEL)	Not applicable

### Operating and Electrical

Starting Time (Nom)	0.5 s
---------------------	-------

### General Information

Nominal Lifetime (Nom)	50000 h
Switching Cycle	50000X

### Light Technical

Color Rendering Index (Nom)	82
Llmf At End Of Nominal Lifetime (Nom)	70 %

### Mechanical and Housing

Bulb Shape	Tube, single-ended
------------	--------------------

### Temperature

T-Ambient (Max)	45 °C
T-Ambient (Min)	-20 °C
T-Storage (Max)	65 °C
T-Storage (Min)	-40 °C

### Controls and Dimming

Order Code	Full Product Name	Dimmable
458364	8.5PL-C/T/COR/26H-827/IF8/P/4P/DIM 10/1	Yes
458372	8.5PL-C/T/COR/26H-830/IF9/P/4P/DIM 10/1	Yes
458380	8.5PL-C/T/COR/26H-835/IF9/P/4P/DIM 10/1	Yes
458398	8.5PL-C/T/COR/26H-840/IF9/P/4P/DIM 10/1	Yes
476069	12PLC/T LED/32H/827/IF/4P/DIM 1PK 10/1	Yes
476077	12PL-C/T/COR/32H-830/IF13/P/4P/DIM 10/1	Yes
476085	12PL-C/T/COR/32H-835/IF14/P/4P/DIM 10/1	Yes
476093	12PL-C/T/COR/32H-840/IF14/P/4P/DIM 10/1	Yes
458406	10.5PL-C/T/COR/26V-827/IF12/P/4P/DIM10/1	Yes
458422	10.5PL-C/T/COR/26V-835/IF13/P/4P/DIM10/1	Yes
458430	10.5PL-C/T/COR/26V-840/IF13/P/4P/DIM10/1	Yes
476101	12PLC/T LED/32V/827/IF/4P/DIM 1PK 10/1	Yes
476119	12PL-C/T/COR/32V-830/IF14/P/4P/DIM 10/1	Yes
476127	12PL-C/T/COR/32V-835/IF14/P/4P/DIM 10/1	Yes
476135	12PL-C/T/COR/32V-840/IF15/P/4P/DIM 10/1	Yes
532333	5PL-C/LED/13H/835/IF5/P/2P 20/1	No
532341	5PL-C/LED/13H/840/IF5/P/2P 20/1	No
532374	5PL-C/LED/13V/835/IF5/P/2P 20/1	No
532382	5PL-C/LED/13V/840/IF5/P/2P 20/1	No
532408	5.5PL-C/LED/13H/830/IF5/P/4P 20/1	Yes
532416	5.5PL-C/LED/13H/835/IF5/P/4P 20/1	Yes
532424	5.5PL-C/LED/13H/840/IF5/P/4P 20/1	Yes
532432	5.5PL-C/LED/13V/827/IF5/P/4P 20/1	Yes
532457	5.5PL-C/LED/13V/835/IF5/P/4P 20/1	Yes
532465	5.5PL-C/LED/13V/840/IF5/P/4P 20/1	Yes

Operating and Electrical

Order Code	Full Product Name	Input Frequency	Voltage (Nom)	Power (Rated) (Nom)
458364	8.5PL-C/T/COR/ 26H-827/IF8/P/4P/DIM 10/1	20000-100000 Hz	120 V	8.5 W
458372	8.5PL-C/T/COR/ 26H-830/IF9/P/4P/DIM 10/1	20000-100000 Hz	120 V	8.5 W
458380	8.5PL-C/T/COR/ 26H-835/IF9/P/4P/DIM 10/1	20000-100000 Hz	120 V	8.5 W
458398	8.5PL-C/T/COR/ 26H-840/IF9/P/4P/DIM 10/1	20000-100000 Hz	120 V	8.5 W
476069	12PLC/T LED/32H/827/IF/4P/DIM 1PK 10/1	20000-100000 Hz	25-55 V	12 W
476077	12PL-C/T/COR/32H-830/ IF13/P/4P/DIM 10/1	20000-100000 Hz	25-55 V	12 W
476085	12PL-C/T/COR/32H-835/ IF14/P/4P/DIM 10/1	20000-100000 Hz	25-55 V	12 W
476093	12PL-C/T/COR/32H-840/ IF14/P/4P/DIM 10/1	20000-100000 Hz	25-55 V	12 W
458406	10.5PL-C/T/COR/26V-827/ IF12/P/4P/DIM10/1	20000-100000 Hz	120 V	10.5 W
458422	10.5PL-C/T/COR/26V-835/ IF13/P/4P/DIM10/1	20000-100000 Hz	120 V	10.5 W
458430	10.5PL-C/T/COR/26V-840/ IF13/P/4P/DIM10/1	20000-100000 Hz	120 V	10.5 W
476101	12PLC/T LED/32V/827/IF/4P/DIM 1PK 10/1	20000-100000 Hz	25-55 V	12 W
476119	12PL-C/T/COR/32V-830/ IF14/P/4P/DIM 10/1	20000-100000 Hz	25-55 V	12 W
476127	12PL-C/T/COR/32V-835/ IF14/P/4P/DIM 10/1	20000-100000 Hz	25-55 V	12 W
476135	12PL-C/T/COR/32V-840/ IF15/P/4P/DIM 10/1	20000-100000 Hz	25-55 V	12 W

Order Code	Full Product Name	Input Frequency	Voltage (Nom)	Power (Rated) (Nom)
532333	5PL- C/LED/13H/835/IF5/P/2P 20/1	50 to 60 Hz	120-277 V	5 W
532341	5PL- C/LED/13H/840/IF5/P/2P 20/1	50 to 60 Hz	120-277 V	5 W
532374	5PL- C/LED/13V/835/IF5/P/2P 20/1	50 to 60 Hz	120-277 V	5 W
532382	5PL- C/LED/13V/840/IF5/P/2P 20/1	50 to 60 Hz	120-277 V	5 W
532408	5.5PL- C/LED/13H/830/IF5/P/4P 20/1	25000-100000 Hz	14-60 V	5.5 W
532416	5.5PL- C/LED/13H/835/IF5/P/4P 20/1	25000-100000 Hz	14-60 V	5.5 W
532424	5.5PL- C/LED/13H/840/IF5/P/4P 20/1	25000-100000 Hz	14-60 V	5.5 W
532432	5.5PL- C/LED/13V/827/IF5/P/4P 20/1	25000-100000 Hz	14-60 V	5.5 W
532457	5.5PL- C/LED/13V/835/IF5/P/4P 20/1	25000-100000 Hz	14-60 V	5.5 W
532465	5.5PL- C/LED/13V/840/IF5/P/4P 20/1	25000-100000 Hz	14-60 V	5.5 W

General Information

Order Code	Full Product Name	Cap-Base
458364	8.5PL-C/T/COR/26H-827/IF8/P/4P/DIM 10/1	G24Q
458372	8.5PL-C/T/COR/26H-830/IF9/P/4P/DIM 10/1	G24Q
458380	8.5PL-C/T/COR/26H-835/IF9/P/4P/DIM 10/1	G24Q
458398	8.5PL-C/T/COR/26H-840/IF9/P/4P/DIM 10/1	G24Q
476069	12PLC/T LED/32H/827/IF/4P/DIM 1PK 10/1	G24Q
476077	12PL-C/T/COR/32H-830/IF13/P/4P/DIM 10/1	G24Q
476085	12PL-C/T/COR/32H-835/IF14/P/4P/DIM 10/1	G24Q
476093	12PL-C/T/COR/32H-840/IF14/P/4P/DIM 10/1	G24Q
458406	10.5PL-C/T/COR/26V-827/IF12/P/4P/DIM10/1	GX24q
458422	10.5PL-C/T/COR/26V-835/IF13/P/4P/DIM10/1	GX24q
458430	10.5PL-C/T/COR/26V-840/IF13/P/4P/DIM10/1	GX24q
476101	12PLC/T LED/32V/827/IF/4P/DIM 1PK 10/1	GX24q
476119	12PL-C/T/COR/32V-830/IF14/P/4P/DIM 10/1	GX24q

Order Code	Full Product Name	Cap-Base
476127	12PL-C/T/COR/32V-835/IF14/P/4P/DIM 10/1	GX24q
476135	12PL-C/T/COR/32V-840/IF15/P/4P/DIM 10/1	GX24q
532333	5PL-C/LED/13H/835/IF5/P/2P 20/1	GX23-2
532341	5PL-C/LED/13H/840/IF5/P/2P 20/1	GX23-2
532374	5PL-C/LED/13V/835/IF5/P/2P 20/1	GX23-2
532382	5PL-C/LED/13V/840/IF5/P/2P 20/1	GX23-2
532408	5.5PL-C/LED/13H/830/IF5/P/4P 20/1	G24Q
532416	5.5PL-C/LED/13H/835/IF5/P/4P 20/1	G24Q
532424	5.5PL-C/LED/13H/840/IF5/P/4P 20/1	G24Q
532432	5.5PL-C/LED/13V/827/IF5/P/4P 20/1	G24Q
532457	5.5PL-C/LED/13V/835/IF5/P/4P 20/1	G24Q
532465	5.5PL-C/LED/13V/840/IF5/P/4P 20/1	G24Q

Light Technical (1/2)

Order Code	Full Product Name	Beam Angle (Nom)	Correlated Color		Luminous Flux (Nom)
			Color Code	Temperature (Nom)	
458364	8.5PL-C/T/COR/ 26H-827/IF8/P/4P/DIM 10/1	120 °	827	2700 K	850 lm
458372	8.5PL-C/T/COR/ 26H-830/IF9/P/4P/DIM 10/1	120 °	830	3000 K	900 lm
458380	8.5PL-C/T/COR/ 26H-835/IF9/P/4P/DIM 10/1	120 °	835	3500 K	900 lm
458398	8.5PL-C/T/COR/ 26H-840/IF9/P/4P/DIM 10/1	120 °	841	4000 K	950 lm
476069	12PLC/T LED/32H/827/IF/4P/DI M 1PK 10/1	120 °	827	2700 K	1300 lm
476077	12PL-C/T/COR/ 32H-830/IF13/P/4P/DIM 10/1	120 °	830	3000 K	1350 lm
476085	12PL-C/T/COR/ 32H-835/IF14/P/4P/DIM 10/1	120 °	835	3500 K	1400 lm
476093	12PL-C/T/COR/ 32H-840/IF14/P/4P/DIM 10/1	120 °	841	4000 K	1450 lm
458406	10.5PL-C/T/COR/ 26V-827/IF12/P/4P/ DIM10/1	120 °	827	2700 K	1200 lm
458422	10.5PL-C/T/COR/ 26V-835/IF13/P/4P/ DIM10/1	120 °	835	3500 K	1200 lm
458430	10.5PL-C/T/COR/ 26V-840/IF13/P/4P/ DIM10/1	120 °	841	4000 K	1300 lm
476101	12PLC/T LED/32V/827/IF/4P/DIM 1PK 10/1	120 °	827	2700 K	1350 lm
476119	12PL-C/T/COR/ 32V-830/IF14/P/4P/DIM 10/1	120 °	830	3000 K	1400 lm

Order Code	Full Product Name	Beam Angle (Nom)	Correlated Color		Luminous Flux (Nom)
			Color Code	Temperature (Nom)	
476127	12PL-C/T/COR/ 32V-835/IF14/P/4P/DIM 10/1	120 °	835	3500 K	1450 lm
476135	12PL-C/T/COR/ 32V-840/IF15/P/4P/DIM 10/1	120 °	841	4000 K	1500 lm
532333	5PL- C/LED/13H/835/IF5/P/2 P 20/1	150 °	835	3500 K	550 lm
532341	5PL- C/LED/13H/840/IF5/P/2 P 20/1	150 °	841	4000 K	580 lm
532374	5PL- C/LED/13V/835/IF5/P/2 P 20/1	150 °	835	3500 K	550 lm
532382	5PL- C/LED/13V/840/IF5/P/2 P 20/1	150 °	841	4000 K	580 lm
532408	5.5PL- C/LED/13H/830/IF5/P/4 P 20/1	150 °	830	3000 K	550 lm
532416	5.5PL- C/LED/13H/835/IF5/P/4 P 20/1	150 °	835	3500 K	550 lm
532424	5.5PL- C/LED/13H/840/IF5/P/4 P 20/1	150 °	841	4000 K	580 lm
532432	5.5PL- C/LED/13V/827/IF5/P/4 P 20/1	150 °	827	2700 K	520 lm
532457	5.5PL- C/LED/13V/835/IF5/P/4 P 20/1	150 °	835	3500 K	550 lm
532465	5.5PL- C/LED/13V/840/IF5/P/4 P 20/1	150 °	841	4000 K	580 lm

Light Technical (2/2)

Order Code	Full Product Name	Luminous Flux (Rated) (Nom)
458364	8.5PL-C/T/COR/26H-827/IF8/P/4P/DIM 10/1	850 lm
458372	8.5PL-C/T/COR/26H-830/IF9/P/4P/DIM 10/1	900 lm
458380	8.5PL-C/T/COR/26H-835/IF9/P/4P/DIM 10/1	900 lm

Order Code	Full Product Name	Luminous Flux (Rated) (Nom)
458398	8.5PL-C/T/COR/26H-840/IF9/P/4P/DIM 10/1	950 lm
476069	12PLC/T LED/32H/827/IF/4P/DIM 1PK 10/1	1300 lm
476077	12PL-C/T/COR/32H-830/IF13/P/4P/DIM 10/1	1350 lm

Order Code	Full Product Name	Luminous Flux (Rated) (Nom)
476085	12PL-C/T/COR/32H-835/IF14/P/4P/DIM 10/1	1400 lm
476093	12PL-C/T/COR/32H-840/IF14/P/4P/DIM 10/1	1450 lm
458406	10.5PL-C/T/COR/26V-827/IF12/P/4P/DIM10/1	1200 lm
458422	10.5PL-C/T/COR/26V-835/IF13/P/4P/DIM10/1	1200 lm
458430	10.5PL-C/T/COR/26V-840/IF13/P/4P/DIM10/1	1300 lm
476101	12PLC/T LED/32V/827/IF/4P/DIM 1PK 10/1	1350 lm
476119	12PL-C/T/COR/32V-830/IF14/P/4P/DIM 10/1	1400 lm
476127	12PL-C/T/COR/32V-835/IF14/P/4P/DIM 10/1	1450 lm
476135	12PL-C/T/COR/32V-840/IF15/P/4P/DIM 10/1	1500 lm
532333	5PL-C/LED/13H/835/IF5/P/2P 20/1	-

Order Code	Full Product Name	Luminous Flux (Rated) (Nom)
532341	5PL-C/LED/13H/840/IF5/P/2P 20/1	-
532374	5PL-C/LED/13V/835/IF5/P/2P 20/1	-
532382	5PL-C/LED/13V/840/IF5/P/2P 20/1	-
532408	5.5PL-C/LED/13H/830/IF5/P/4P 20/1	-
532416	5.5PL-C/LED/13H/835/IF5/P/4P 20/1	-
532424	5.5PL-C/LED/13H/840/IF5/P/4P 20/1	-
532432	5.5PL-C/LED/13V/827/IF5/P/4P 20/1	-
532457	5.5PL-C/LED/13V/835/IF5/P/4P 20/1	-
532465	5.5PL-C/LED/13V/840/IF5/P/4P 20/1	-

**Mechanical and Housing**

Order Code	Full Product Name	Bulb Finish
458364	8.5PL-C/T/COR/26H-827/IF8/P/4P/DIM 10/1	Frosted
458372	8.5PL-C/T/COR/26H-830/IF9/P/4P/DIM 10/1	Frosted
458380	8.5PL-C/T/COR/26H-835/IF9/P/4P/DIM 10/1	Frosted
458398	8.5PL-C/T/COR/26H-840/IF9/P/4P/DIM 10/1	Frosted
476069	12PLC/T LED/32H/827/IF/4P/DIM 1PK 10/1	Frosted
476077	12PL-C/T/COR/32H-830/IF13/P/4P/DIM 10/1	Frosted
476085	12PL-C/T/COR/32H-835/IF14/P/4P/DIM 10/1	Frosted
476093	12PL-C/T/COR/32H-840/IF14/P/4P/DIM 10/1	Frosted
458406	10.5PL-C/T/COR/26V-827/IF12/P/4P/DIM10/1	Frosted
458422	10.5PL-C/T/COR/26V-835/IF13/P/4P/DIM10/1	Frosted
458430	10.5PL-C/T/COR/26V-840/IF13/P/4P/DIM10/1	Frosted
476101	12PLC/T LED/32V/827/IF/4P/DIM 1PK 10/1	Frosted
476119	12PL-C/T/COR/32V-830/IF14/P/4P/DIM 10/1	Frosted

Order Code	Full Product Name	Bulb Finish
476127	12PL-C/T/COR/32V-835/IF14/P/4P/DIM 10/1	Frosted
476135	12PL-C/T/COR/32V-840/IF15/P/4P/DIM 10/1	Frosted
532333	5PL-C/LED/13H/835/IF5/P/2P 20/1	-
532341	5PL-C/LED/13H/840/IF5/P/2P 20/1	-
532374	5PL-C/LED/13V/835/IF5/P/2P 20/1	-
532382	5PL-C/LED/13V/840/IF5/P/2P 20/1	-
532408	5.5PL-C/LED/13H/830/IF5/P/4P 20/1	-
532416	5.5PL-C/LED/13H/835/IF5/P/4P 20/1	-
532424	5.5PL-C/LED/13H/840/IF5/P/4P 20/1	-
532432	5.5PL-C/LED/13V/827/IF5/P/4P 20/1	-
532457	5.5PL-C/LED/13V/835/IF5/P/4P 20/1	-
532465	5.5PL-C/LED/13V/840/IF5/P/4P 20/1	-

**Temperature**

Order Code	Full Product Name	T-Case Maximum (Nom)
458364	8.5PL-C/T/COR/26H-827/IF8/P/4P/DIM 10/1	60 °C
458372	8.5PL-C/T/COR/26H-830/IF9/P/4P/DIM 10/1	60 °C
458380	8.5PL-C/T/COR/26H-835/IF9/P/4P/DIM 10/1	60 °C
458398	8.5PL-C/T/COR/26H-840/IF9/P/4P/DIM 10/1	60 °C
476069	12PLC/T LED/32H/827/IF/4P/DIM 1PK 10/1	25 °C
476077	12PL-C/T/COR/32H-830/IF13/P/4P/DIM 10/1	25 °C
476085	12PL-C/T/COR/32H-835/IF14/P/4P/DIM 10/1	25 °C
476093	12PL-C/T/COR/32H-840/IF14/P/4P/DIM 10/1	25 °C
458406	10.5PL-C/T/COR/26V-827/IF12/P/4P/DIM10/1	60 °C
458422	10.5PL-C/T/COR/26V-835/IF13/P/4P/DIM10/1	60 °C
458430	10.5PL-C/T/COR/26V-840/IF13/P/4P/DIM10/1	60 °C
476101	12PLC/T LED/32V/827/IF/4P/DIM 1PK 10/1	25 °C
476119	12PL-C/T/COR/32V-830/IF14/P/4P/DIM 10/1	25 °C
476127	12PL-C/T/COR/32V-835/IF14/P/4P/DIM 10/1	25 °C
476135	12PL-C/T/COR/32V-840/IF15/P/4P/DIM 10/1	25 °C
532333	5PL-C/LED/13H/835/IF5/P/2P 20/1	70 °C
532341	5PL-C/LED/13H/840/IF5/P/2P 20/1	70 °C
532374	5PL-C/LED/13V/835/IF5/P/2P 20/1	70 °C
532382	5PL-C/LED/13V/840/IF5/P/2P 20/1	70 °C

Order Code	Full Product Name	T-Case Maximum (Nom)
532408	5.5PL-C/LED/13H/830/IF5/P/4P 20/1	75 °C
532416	5.5PL-C/LED/13H/835/IF5/P/4P 20/1	75 °C
532424	5.5PL-C/LED/13H/840/IF5/P/4P 20/1	75 °C
532432	5.5PL-C/LED/13V/827/IF5/P/4P 20/1	70 °C
532457	5.5PL-C/LED/13V/835/IF5/P/4P 20/1	70 °C
532465	5.5PL-C/LED/13V/840/IF5/P/4P 20/1	70 °C

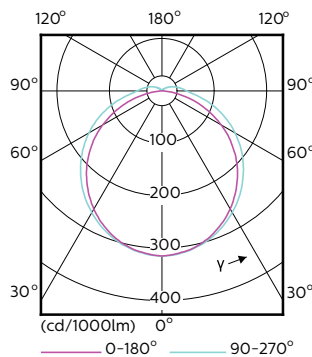

# PL-C/T

