



CorePro LED PLC 2P

LED PLC 6.5W 840 2P G24d-2

CorePro LED PLC 2P integrates a LED light source into a traditional fluorescent form factor. This product is the ideal solution for uplampping in general lighting applications: it meets basic lighting requirements, offers significant energy savings, and is environmentally friendly.

Product data

General information		Warm Up Time to 60% Light (Nom)	
Base	G24D-2 [G24d-2]	Power Factor (Nom)	0.9
EU RoHS compliant	Yes	Voltage (Nom)	220-240 V
Nominal Lifetime (Nom)	30000 h	Temperature	
Switching Cycle	50000X	T-Ambient (Max)	95 °F
Light technical		T-Ambient (Min)	-4 °F
Color Code	841 [CCT of 4100K (841)]	T-Storage (Max)	149 °F
Beam Angle (Nom)	120 °	T-Storage (Min)	-40 °F
Initial lumen (Nom)	700 lm	T-Case Maximum (Nom)	149 °F
Color Designation	Cool White (CW)	Controls and dimming	
Correlated Color Temperature (Nom)	4000 K	Dimmable	No
Luminous Efficacy (rated) (Nom)	107.00 lm/W	Mechanical and housing	
Color Consistency	<6	Product Length	4 in
Color Rendering Index (Nom)	83	Bulb Shape	Tube, single-ended
LLMF At End Of Nominal Lifetime (Nom)	70 %	Approval and application	
Operating and electrical		Energy Saving Product	Yes
Input Frequency	50 to 60 Hz	Approbation Marks	TUV CE marking
Power (Rated) (Nom)	6.5 W	Energy Consumption kWh/1000 h	9 kWh
Lamp Current (Max)	35 mA		
Lamp Current (Min)	25 mA		
Starting Time (Nom)	0.5 s		

CorePro LED PLC 2P

Product data

Order product name	LED PLC 6.5W 840 2P G24d-2
EAN/UPC - Product	8718696670057
Order code	366260
Numerator - Quantity Per Pack	1

Numerator - Packs per outer box	10
Material Nr. (12NC)	929001201508
Copy Net Weight (Piece)	0.17 lb

Dimensional drawing



Product	D1	D2	A1	A2	A3
LED PLC 6.5W 840 2P G24d-2	1 in	1-1/8 in	4-3/16 in	4-15/16 in	5-13/16 in

LED PLC 6.5W 840 2P G24d-2

Photometric data

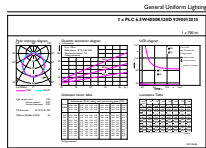

General Information E1 Photo Lighting E1 Page 10

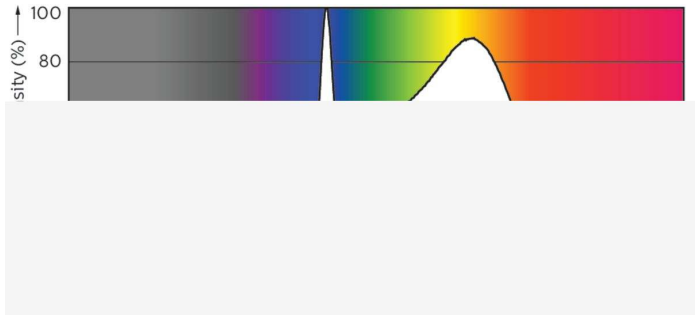

LEDtube PLC 100mm 7W G24D-2 840 700lm

LEDtube PLC 100mm 9W G24Q-3 840 1000lm

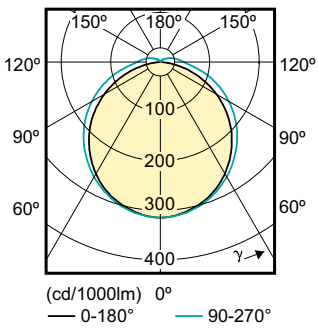

CorePro LED PLC 2P

Lifetime

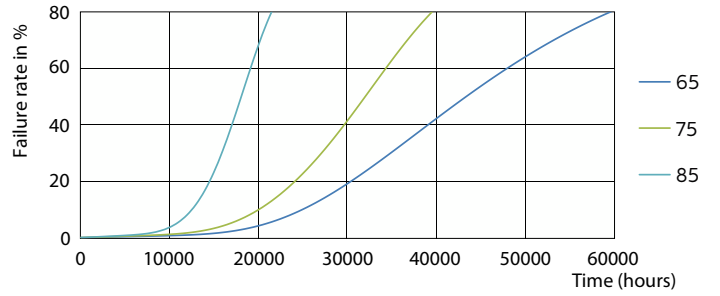
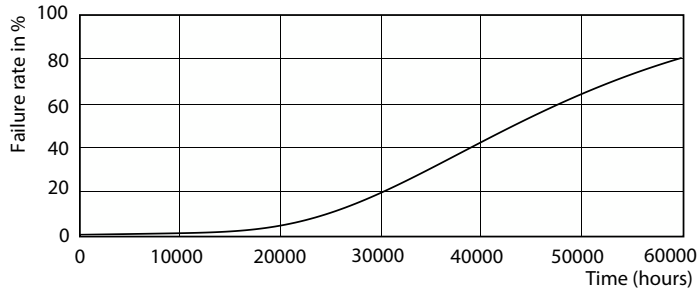

LEDtube PLC 100mm 7W G24D-2 830 650lm

LEDtube PLC 100mm 7W G24D-2 830 650lm

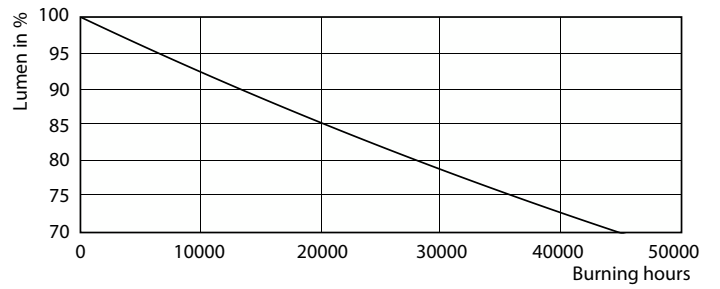
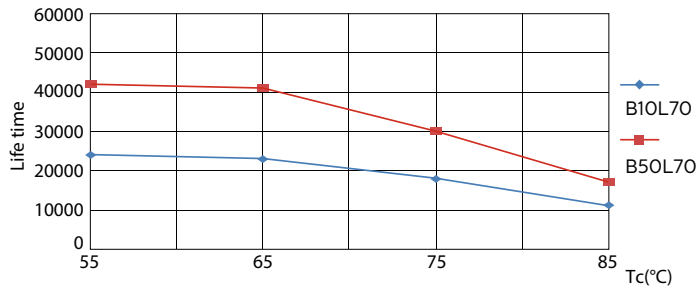

LEDtube PLC 100mm 7W G24D-2 830 650lm

LEDtube PLC 100mm 7W G24D-2 830 650lm

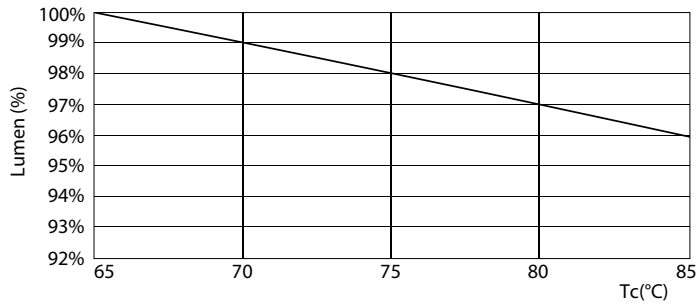

LEDtube PLC 100mm 7W G24D-2 830 650lm

CorePro LED PLC 2P

